

Computability

voorjaar 2022

<https://liacs.leidenuniv.nl/~vlietrvan1/computability/>

college 2, 17 februari 2022

7. Turing Machines

7.1. A General Model of Computation

7.2. Turing Machines as Language Acceptors

7.3. Turing Machines That Compute Partial Functions

Part of an exercise from exercise class 1

Exercise 7.4.

For each of the following languages, draw a transition diagram for a Turing machine that accepts that language.

a. . . .

b. $\{a^i b^j \mid i < j\}$

c. . . .

d. . . .

Example 7.7. Accepting $L = \{a^i b a^j \mid 0 \leq i < j\}$

Example 7.7. Accepting $L = \{a^i b a^j \mid 0 \leq i < j\}$

$\underline{\Delta} a a b a a a a$
 $\Delta \Delta a b a a a a$
 $\Delta \Delta a b \Delta a a a$
 $\Delta \Delta \Delta b \Delta a a a$
 $\Delta \Delta \Delta b \Delta \Delta a a$

Example 7.7. Accepting $L = \{a^i b a^j \mid 0 \leq i < j\}$

What if $x \notin L$?

Example 7.7. Accepting $L = \{a^i b a^j \mid 0 \leq i < j\}$

To illustrate that a Turing machine T may run forever for an input that is not in $L(T)$. No problem!

No problem?

Definition 2.11. A Finite Automaton

A *finite automaton* (FA) is a 5-tuple $(Q, \Sigma, q_0, A, \delta)$, where ...

Definition 5.1. A Pushdown Automaton

A *pushdown automaton* (PDA) is a 7-tuple $M = (Q, \Sigma, \Gamma, q_0, Z_0, A, \delta)$, where ...

Definition 7.1. Turing machines

A Turing machine (TM) is ...

Part of a slide from lecture 1

Turing machine

Turing machine has a finite alphabet of symbols.

(actually two alphabets. . .)

Turing machine has a finite number of states.

7.1. A General Model of Computation

Definition 7.1. Turing machines

A Turing machine (TM) is a 5-tuple $T = (Q, \Sigma, \Gamma, q_0, \delta)$, where

Q is a finite set of states. The two *halt* states h_a and h_r are not elements of Q .

Σ , the input alphabet, and Γ , the tape alphabet, are both finite sets, with $\Sigma \subseteq \Gamma$. The *blank* symbol Δ is not an element of Γ .

q_0 , the initial state, is an element of Q .

δ is the transition function: ...

Part of a slide from lecture 1

**Assumptions about a human computer
working with a pencil and paper:**

1. . . .
2. Each step taken by the computer depends only on the symbol he is currently examining and on his “state of mind” at the time;
3. . . .

A slide from lecture 1

A move of a Turing machine consists of:

1. Changing from the current state to another, possibly different state;
2. Replacing the symbol in the current square by another, possibly different symbol;
3. Leaving the tape head on the current square, or moving it one square to the right, or moving it one square to the left if it is not already on the leftmost square.

$$\delta(p, X) = (q, Y, D)$$

$$f(n) = n!$$

$$f(x, y) = x * y$$

Definition 7.1. Turing machines

A Turing machine (TM) is a 5-tuple $T = (Q, \Sigma, \Gamma, q_0, \delta)$, where

Q is a finite set of states. The two *halt* states h_a and h_r are not elements of Q .

Σ , the input alphabet, and Γ , the tape alphabet, are both finite sets, with $\Sigma \subseteq \Gamma$. The *blank* symbol Δ is not an element of Γ .

q_0 , the initial state, is an element of Q .

δ is the transition **function**:

$$\delta : Q \times (\Gamma \cup \{\Delta\}) \rightarrow (Q \cup \{h_a, h_r\}) \times (\Gamma \cup \{\Delta\}) \times \{R, L, S\}$$

If q is h_a or h_r , the move causes T to halt

What if $D = L$ and T is on square 0?

Normally, TM starts with

- input string starting in square 1 and all other squares blank,
- and its tape head on square 0.

Tape always contains finite number of nonblanks.

Notation:

configuration...

Notation:

description of tape contents: $x\underline{\sigma}y$ or $x\underline{y}$

$$x\underline{y} = x\underline{y}\Delta = x\underline{y}\Delta\Delta$$

if $y = \Lambda$, then $x\underline{\Delta}$

Notation:

description of tape contents: $x\underline{\sigma}y$ or $x\underline{y}$

$$x\underline{y} = x\underline{y}\Delta = x\underline{y}\Delta\Delta$$

if $y = \Lambda$, then $x\underline{\Delta}$

configuration $xqy = xqy\Delta = xqy\Delta\Delta$

if $y = \Lambda$, then $xq\Delta$

$$(Q \cup \{h_a, h_r\}) \cap (\Gamma \cup \{\Delta\}) = \emptyset$$

Notation:

description of tape contents: $x\underline{\sigma}y$ or $x\underline{y}$

$$x\underline{y} = x\underline{y}\Delta = x\underline{y}\Delta\Delta$$

if $y = \Lambda$, then $x\underline{\Delta}$

configuration $xqy = xqy\Delta = xqy\Delta\Delta$

if $y = \Lambda$, then $xq\Delta$

$$\begin{array}{l} \text{move: } xqy \vdash_T zrw \quad xqy \vdash_T^* zrw \\ \quad \quad \quad xqy \vdash zrw \quad xqy \vdash^* zrw \end{array}$$

example: configuration $aabqa\Delta a$ and $\delta(q, a) = (r, \Delta, L)$

initial configuration corresponding to input x: ...

Notation:

description of tape contents: $x\underline{\sigma}y$ or $x\underline{y}$

$$x\underline{y} = x\underline{y}\Delta = x\underline{y}\Delta\Delta$$

if $y = \Lambda$, then $x\underline{\Delta}$

configuration $xqy = xqy\Delta = xqy\Delta\Delta$

if $y = \Lambda$, then $xq\Delta$

$$\begin{array}{ll} \text{move: } xqy \vdash_T zrw & xqy \vdash_T^* zrw \\ & xqy \vdash zrw \quad xqy \vdash^* zrw \end{array}$$

example: configuration $aabqa\Delta a$ and $\delta(q, a) = (r, \Delta, L)$

initial configuration corresponding to input x : $q_0\Delta x$

7.2. Turing Machines as Language Acceptors

Example 7.3. A TM Accepting a Regular Language

$$L = \{a, b\}^* \{ab\} \{a, b\}^* \cup \{a, b\}^* \{ba\}$$

First a finite automaton:

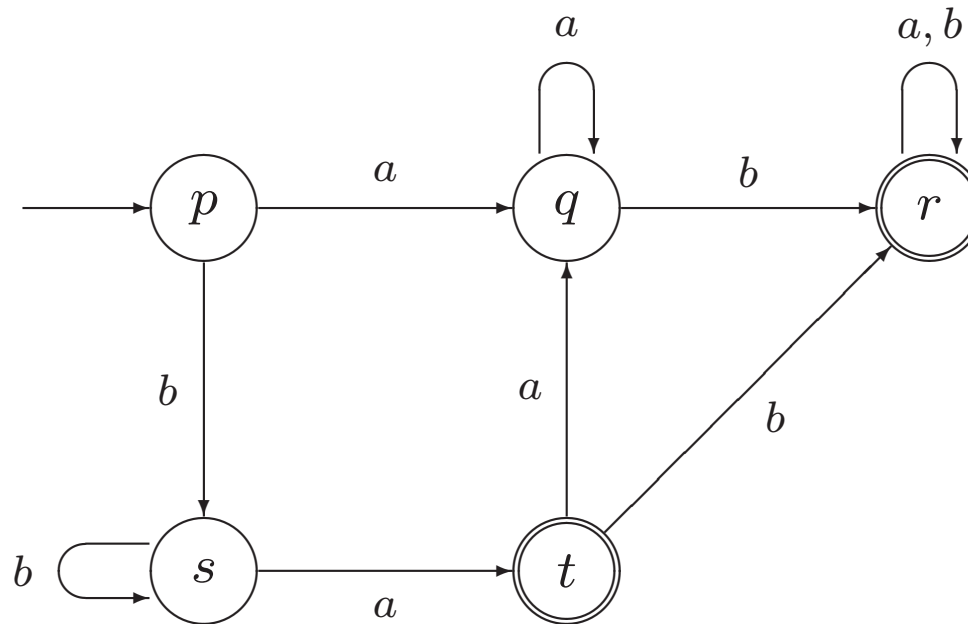

Example 7.3. A TM Accepting a Regular Language

$$L = \{a, b\}^* \{ab\} \{a, b\}^* \cup \{a, b\}^* \{ba\}$$

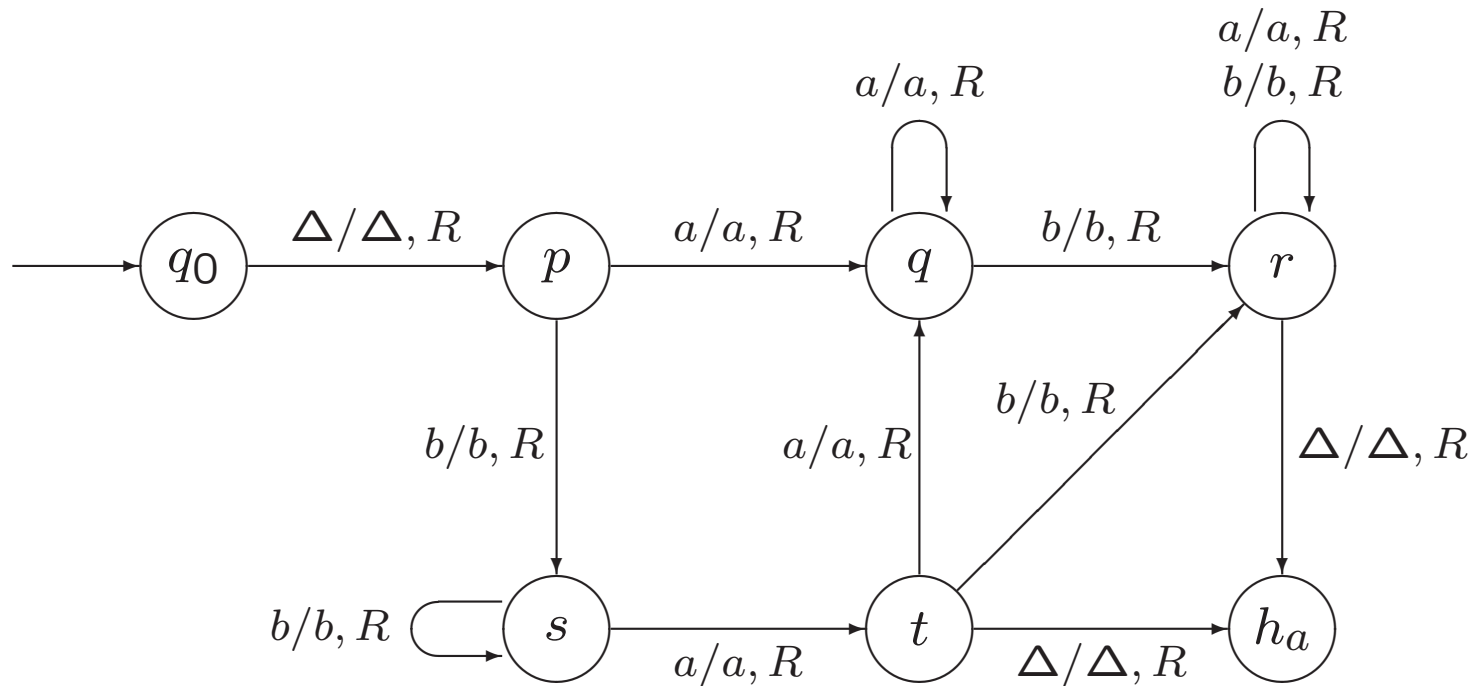

Example 7.3. A TM Accepting a Regular Language

$$L = \{a, b\}^* \{ab\} \{a, b\}^* \cup \{a, b\}^* \{ba\}$$

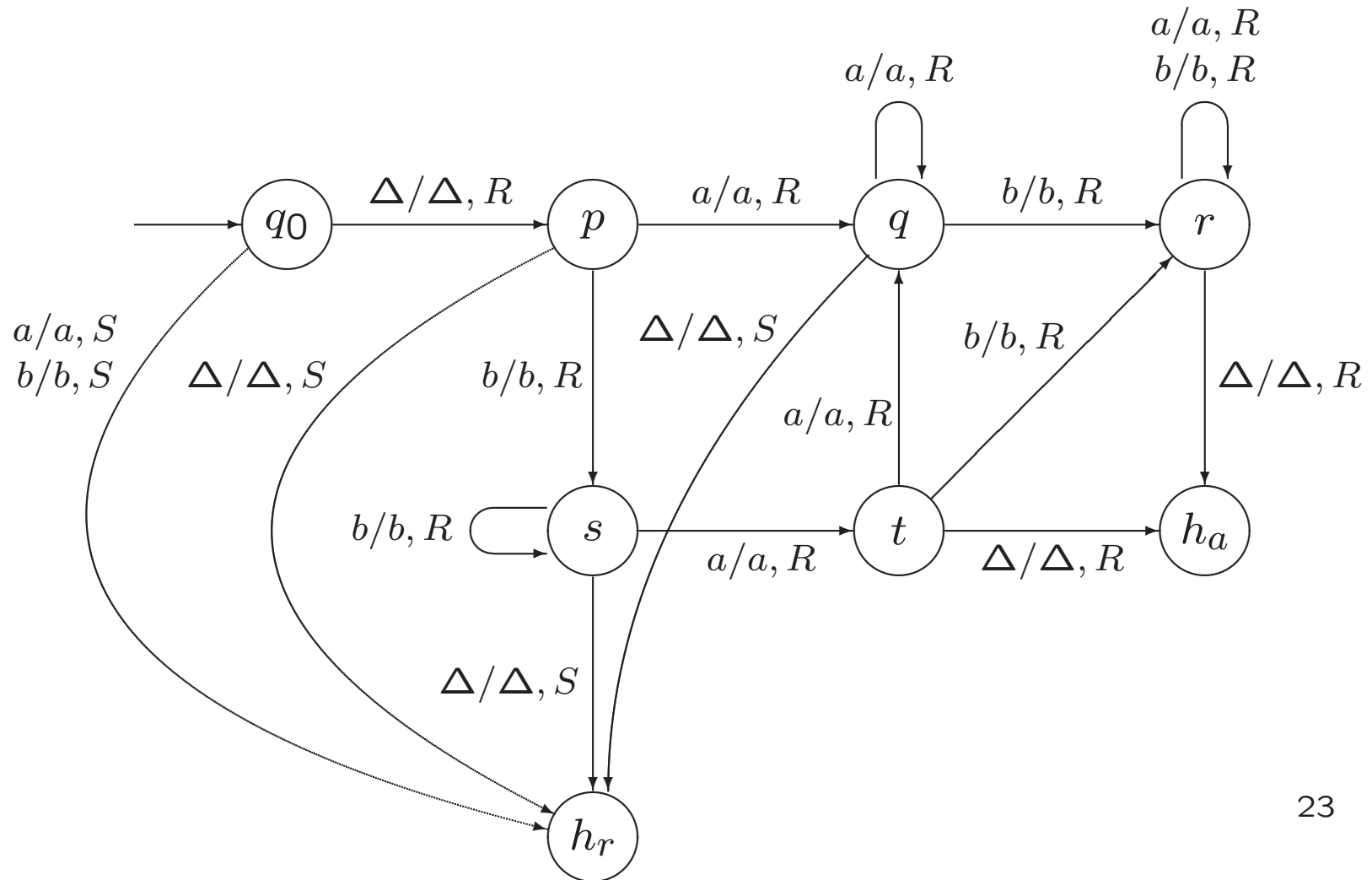

Example 7.3. A TM Accepting a Regular Language

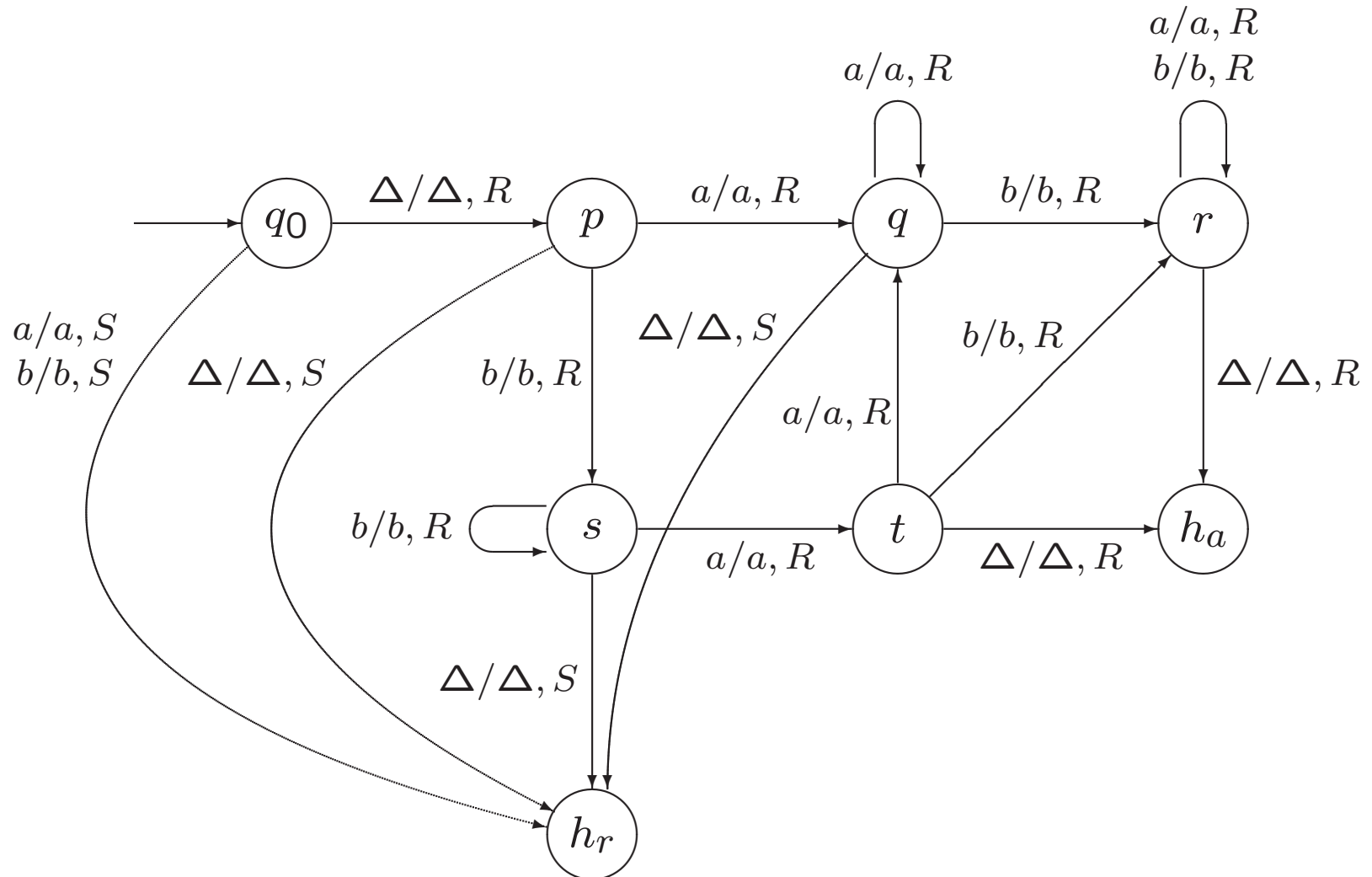

$q_0 \Delta aaba \vdash \Delta paaba \vdash \Delta aqaba \vdash \Delta aaqba \vdash \Delta aabra \vdash \Delta aabar \Delta \vdash \Delta aaba \Delta h_a \Delta$

Example 7.3. A TM Accepting a Regular Language

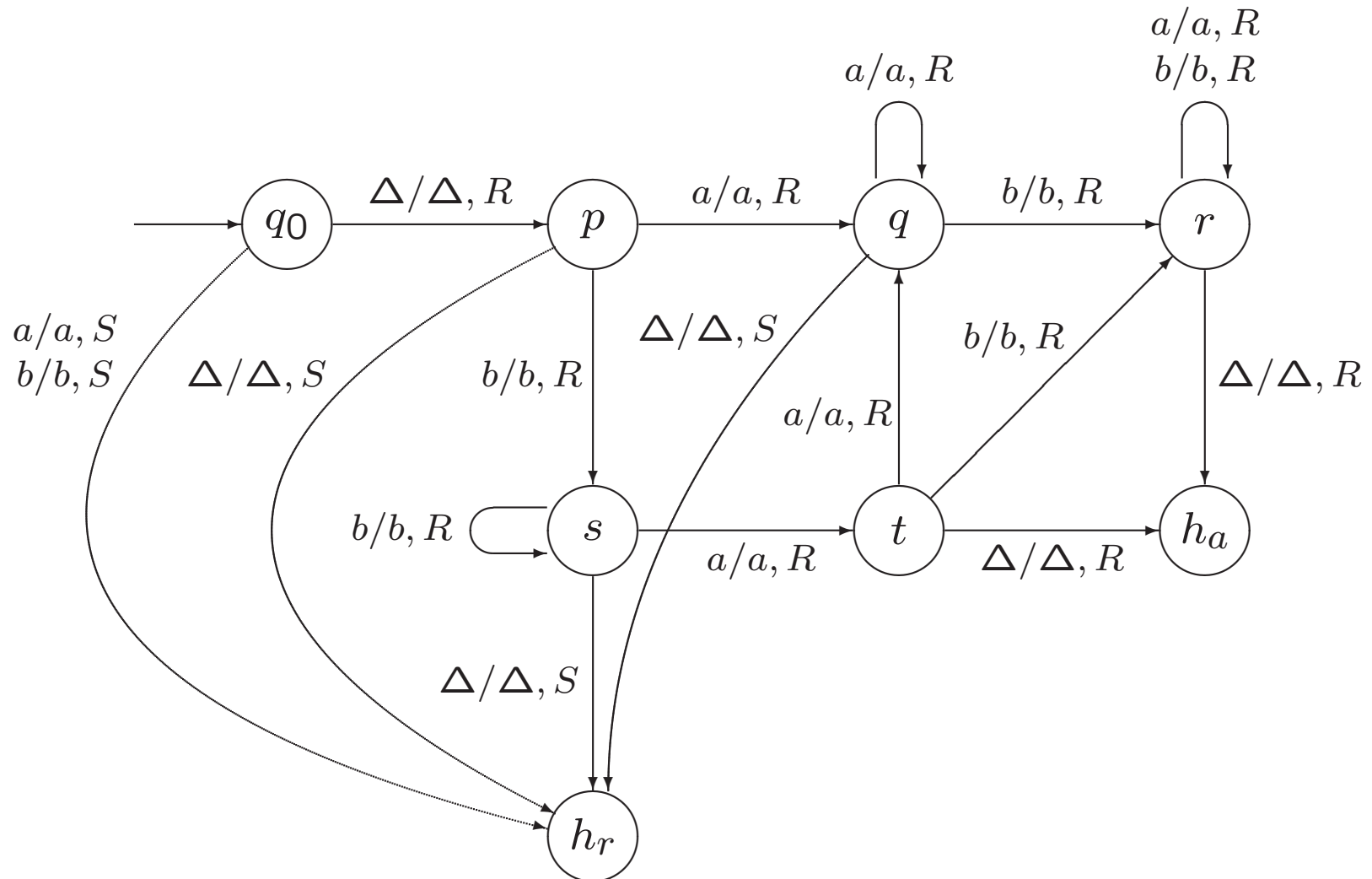

$q_0 \Delta bbaa \vdash \Delta p bbaa \vdash \Delta s bbaa \vdash \Delta bbsaa \vdash \Delta bbata \vdash \Delta bbaaq \Delta \vdash \Delta bbaah_r \Delta$

Properties of notation xqy

- all information about configuration in one string
- move TM yields only local change

Useful, when ...

7.2. Turing Machines as Language Acceptors

Definition 7.2. Acceptance by a TM

If $T = (Q, \Sigma, \Gamma, q_0, \delta)$ is a TM and $x \in \Sigma^*$,
 x is accepted by T if

$$q_0 \Delta x \vdash_T^* w h_a y$$

for **some strings** $w, y \in (\Gamma \cup \{\Delta\})^*$

(i.e., if, starting in the initial configuration corresponding to input x , T eventually halts in the accepting state).

N.B.: sequence of moves leading to h_a is unique

A language $L \subseteq \Sigma^*$ is accepted by T if $L = L(T)$, where

$$L(T) = \{x \in \Sigma^* \mid x \text{ is accepted by } T \}$$

If $x \notin L(T)$, ...

7.3. Turing Machines That Compute **Partial** Functions

$$f(x, y) = x/y$$

with real numbers

$f(x, y)$ is **not defined** if $y = 0$,

i.e., if $y = 0$, then (x, y) is not in domain of f

7.3. Turing Machines That Compute Partial Functions

Example 7.10. The Reverse of a String

7.3. Turing Machines That Compute Partial Functions

Example 7.10. The Reverse of a String

$\underline{\Delta} a a b a b$
 $\Delta A a b a b$
 $\Delta A a b a A$
 $\Delta B a b a A$
 $\Delta B A b a A$
 $\Delta B A b A A$
 $\Delta B A b A A$
 $\Delta B A B A A$
 $\underline{\Delta} b a b a a$

Definition 7.1. Turing machines

A Turing machine (TM) is a 5-tuple $T = (Q, \Sigma, \Gamma, q_0, \delta)$, where

Q is a finite set of states. The two *halt* states h_a and h_r are not elements of Q .

Σ , the input alphabet, and Γ , the tape alphabet, are both finite sets, with $\Sigma \subseteq \Gamma$. The *blank* symbol Δ is not an element of Γ .

q_0 , the initial state, is an element of Q .

δ is the transition function:

$$\delta : Q \times (\Gamma \cup \{\Delta\}) \rightarrow (Q \cup \{h_a, h_r\}) \times (\Gamma \cup \{\Delta\}) \times \{R, L, S\}$$

Simple version of:

Definition 7.9. A Turing Machine Computing a Function

Let $T = (Q, \Sigma, \Gamma, q_0, \delta)$ be a Turing machine, and f a **partial** function on Σ^* with values in Γ^* . We say that T computes f if for every x in the **domain** of f ,

$$q_0 \Delta x \vdash_T^* h_a \Delta f(x)$$

and **no other input string** is accepted by T .

Definition 7.9. A Turing Machine Computing a Function

Let $T = (Q, \Sigma, \Gamma, q_0, \delta)$ be a Turing machine, k a natural number, and f a partial function on $(\Sigma^*)^k$ with values in Γ^* . We say that T computes f if for every (x_1, x_2, \dots, x_k) in the domain of f ,

$$q_0 \Delta x_1 \Delta x_2 \Delta \dots \Delta x_k \vdash_T^* h_a \Delta f(x_1, x_2, \dots, x_k)$$

and no other input that is a k -tuple of strings is accepted by T .

A partial function $f : (\Sigma^*)^k \rightarrow \Gamma^*$ is Turing-computable, or simply computable, if there is a TM that computes f .

k can be 0...

Functions on natural numbers. . .

Example 7.12. The Quotient and Remainder Mod 2

Example.

Dividing by 3

Example.

Accepting $\{xyx \mid x, y \in \{a, b\}^* \text{ and } |x| = |y|\}$

Exercise.

Draw a TM that computes the function $f(x, y) = x \bmod y$

Hint: implement the following algorithm:

```
while (x >= y)
  x = x - y;
```

Make this exercise yourself.

Example 7.3. A TM Accepting a Regular Language

$$L = \{a, b\}^* \{ab\} \{a, b\}^* \cup \{a, b\}^* \{ba\}$$

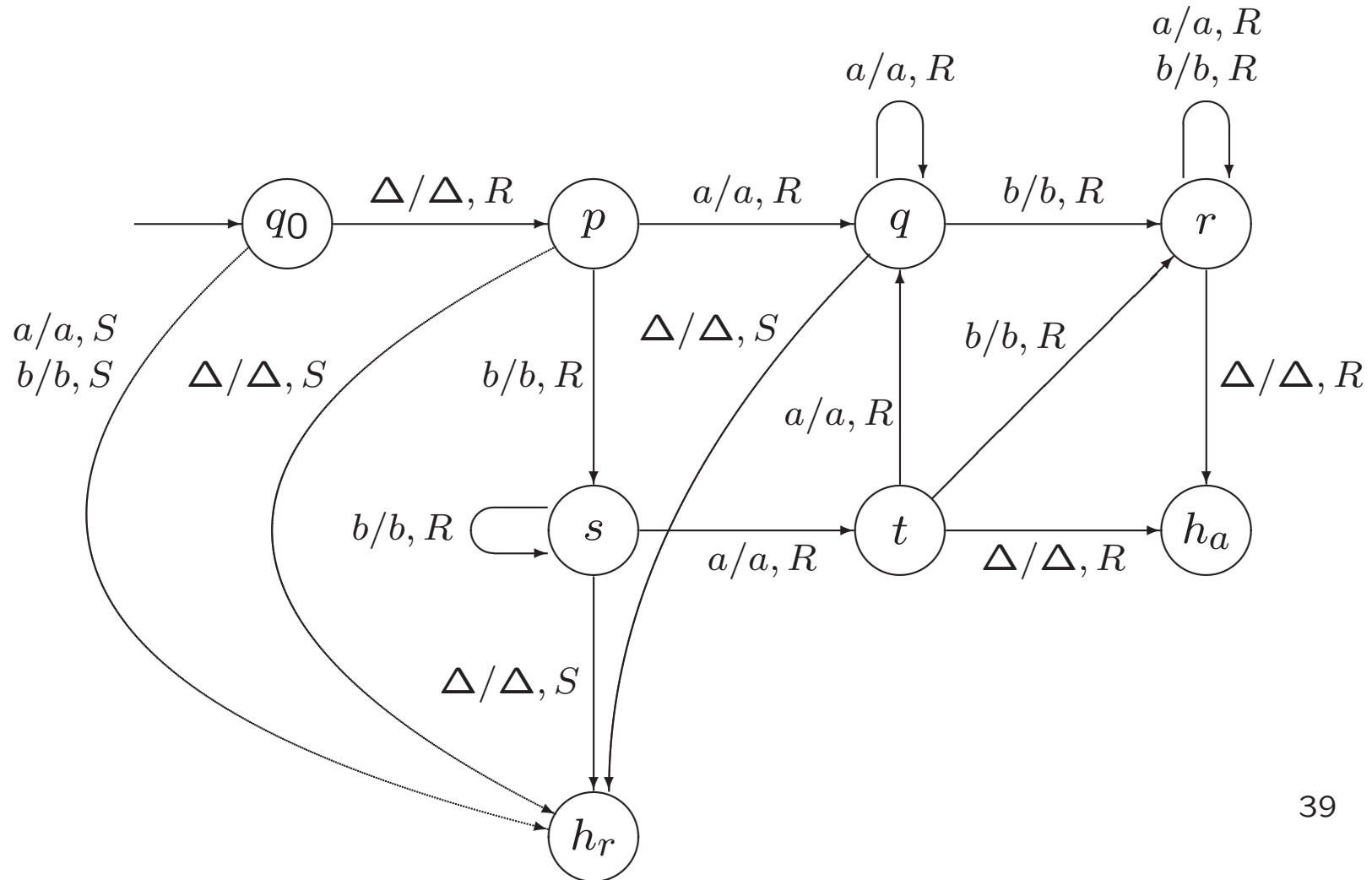

Example 7.14. The Characteristic Function of a Set

$$L = \{a, b\}^* \{ab\} \{a, b\}^* \cup \{a, b\}^* \{ba\}$$

$\chi_L : \{a, b\}^* \rightarrow \{0, 1\}$, defined by

$$\chi_L(x) = \begin{cases} 1 & \text{if } x \in L \\ 0 & \text{if } x \notin L \end{cases}$$

Example 7.3. A TM Accepting a Regular Language

$$L = \{a, b\}^* \{ab\} \{a, b\}^* \cup \{a, b\}^* \{ba\}$$

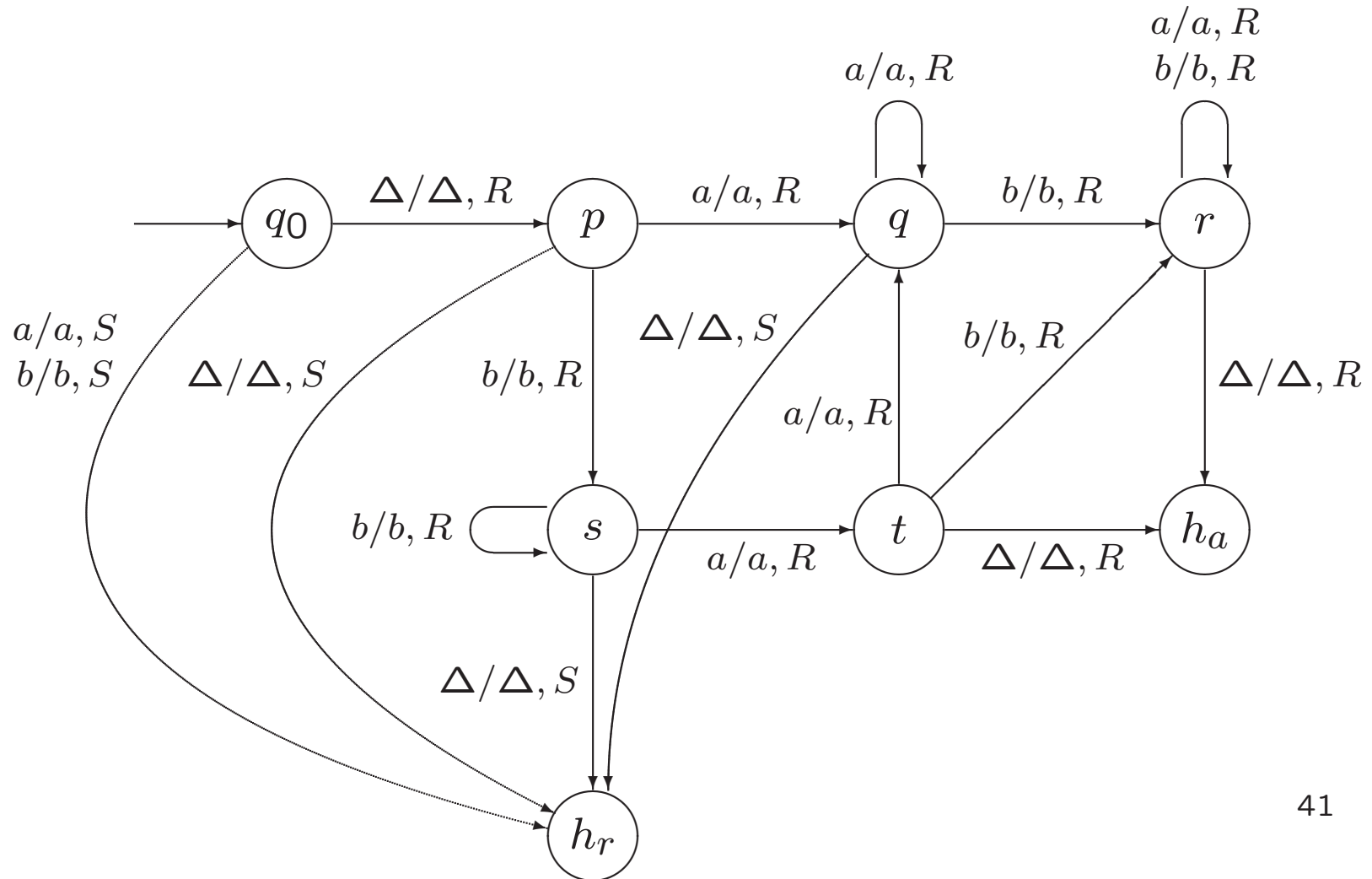

Example 7.14. The Characteristic Function of a Set

$$L = \{a, b\}^* \{ab\} \{a, b\}^* \cup \{a, b\}^* \{ba\}$$

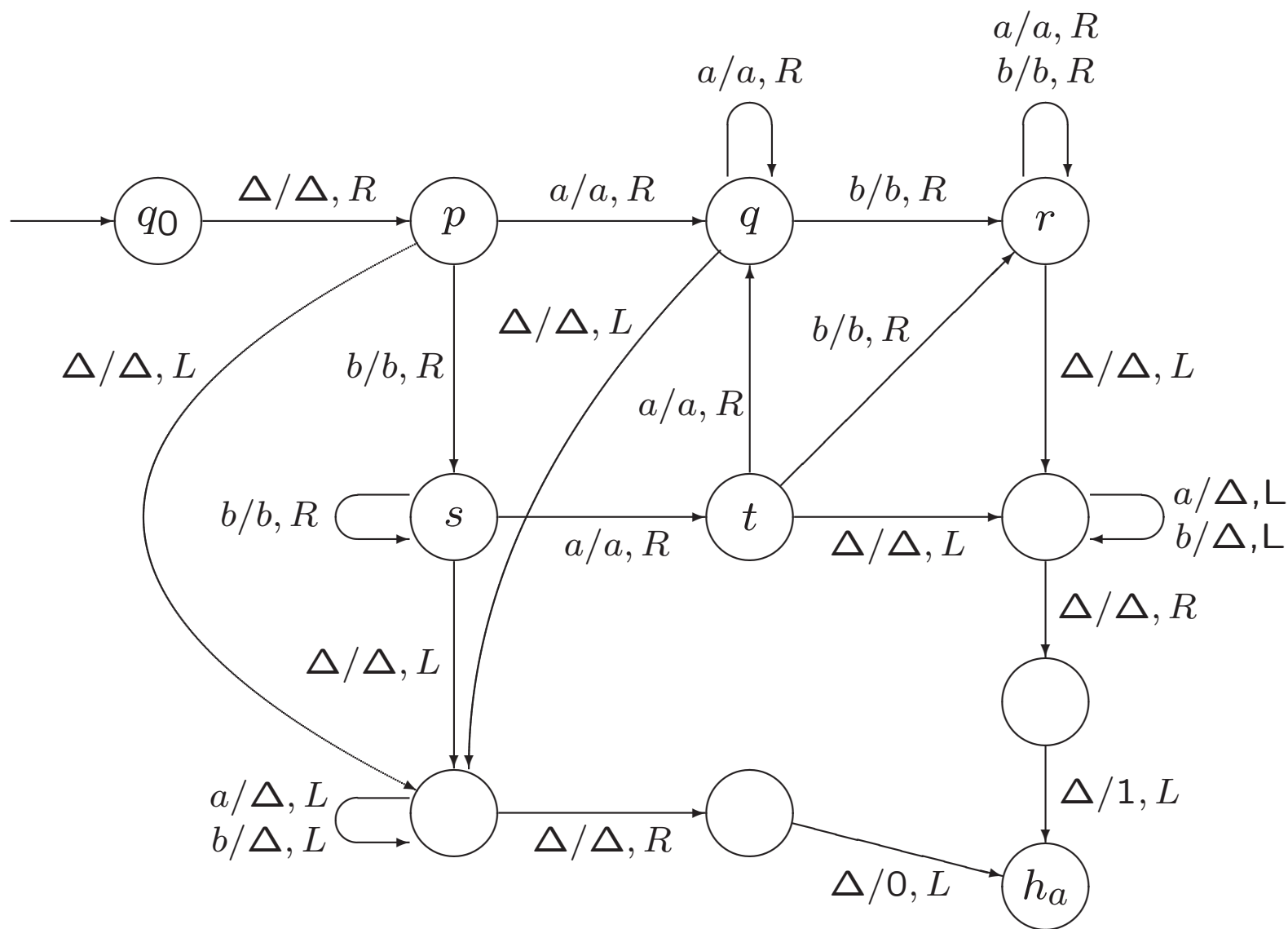

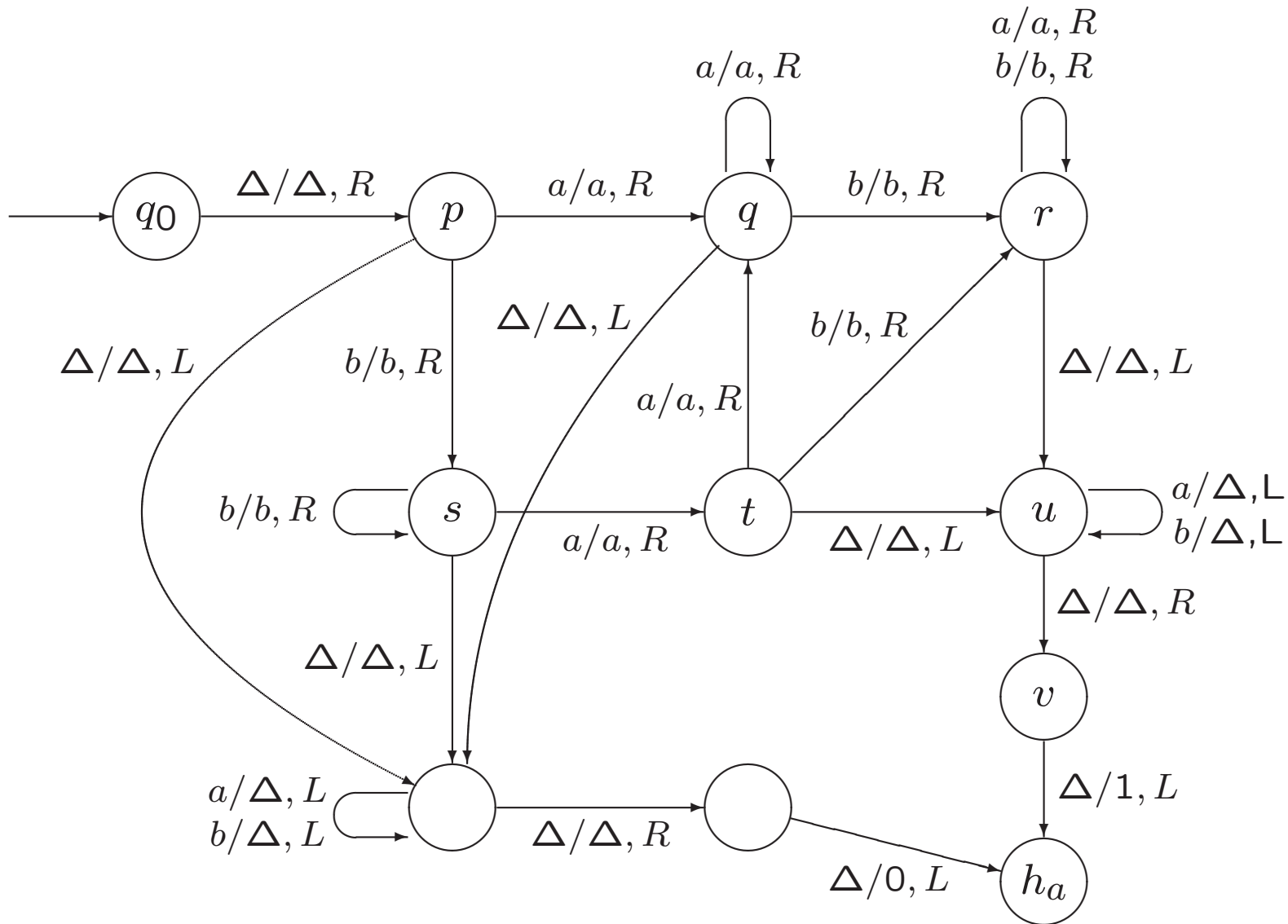

$q_0 \Delta aaba \vdash \Delta paaba \vdash \Delta aqaba \vdash \Delta aaqba \vdash \Delta aabra \vdash \Delta aabar \Delta \vdash$
 $\Delta aabua \vdash \Delta aaub \vdash \Delta aua \vdash \Delta ua \vdash u \Delta \vdash \Delta v \Delta \vdash h_a \Delta 1$

Example 7.14. The Characteristic Function of a Set

$$\chi_L(x) = \begin{cases} 1 & \text{if } x \in L \\ 0 & \text{if } x \notin L \end{cases}$$

From computing χ_L to accepting L

From accepting L to computing χ_L

Een Intermezzo

<http://www.youtube.com/watch?v=E3keLeMwfHY>